

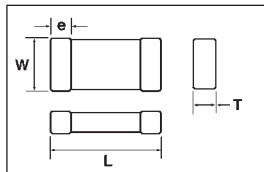

Quick Reference

Series	Features	Page
Multilayer Chip Type		
SNPO	0402-3035 Case Sizes 6.3 - 4KV	4
SX7R	0402-3035 Case Sizes 6.3 - 4KV	5
SY5V	0402-3035 Case Sizes 10 - 500V	6
SZ5U	0402-3035 Case Sizes 10 - 1KV	7
Multilayer Radial Leaded Type		
RNPO	2.5/5.0mm Lead Spacing 25 - 100V	8
RX7R	2.5/5.0mm Lead Spacing 25 - 100V	
RY5V	2.5/5.0mm Lead Spacing 25 - 63V	
RZ5U	2.5/5.0mm Lead Spacing 25 - 63V	
Multilayer Axial Leaded Type		
ANPO	5mm Body Length 50 - 100V	9
AX7R	5mm Body Length 50 - 100V	
AZ5U	5mm Body Length 50 - 100V	

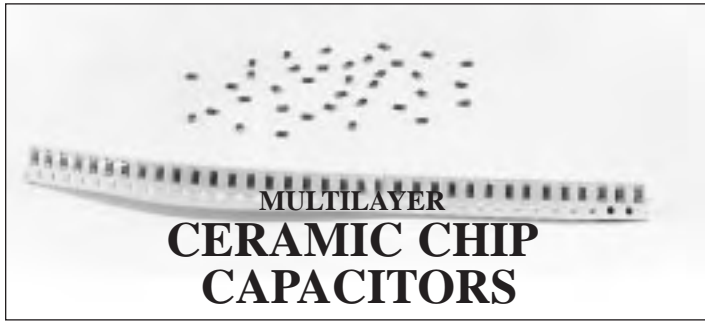

Tolerance on Dimensions
"L" and "W": $\pm 0.35\text{mm}(0.014")\text{max.}$

CASE DIMENSIONS AND TOLERANCES

Case Code	Dimensions mm(inches)			
	L	W	T max.	e
0402	1.00(0.040)	0.50(0.020)	0.55(0.022)	0.20(0.008)
0603	1.60(0.063)	0.80(0.032)	0.90(0.035)	0.30(0.012)
0805	2.03(0.080)	1.27(0.050)	1.27(0.050)	0.50(0.020)
1206	3.20(0.125)	1.60(0.063)	1.35(0.053)	0.50(0.020)
1210	3.20(0.125)	2.50(0.098)	1.60(0.063)	0.50(0.020)
1808	4.50(0.177)	2.03(0.800)	1.80(0.071)	0.50(0.020)
1812	4.50(0.177)	3.20(0.125)	2.20(0.087)	0.60(0.027)
2220	5.70(0.224)	5.00(0.197)	2.80(0.110)	0.65(0.026)
2225	5.70(0.224)	6.30(0.248)	2.80(0.110)	0.65(0.026)
3012	7.60(0.299)	3.20(0.125)	5.70(0.224)	0.70(0.028)
3035	7.60(0.299)	8.90(0.350)	6.30(0.248)	0.70(0.028)

"L" & "W" tolerances: $\pm 0.35\text{mm}(0.014")\text{max.}$

STANDARD PACKAGING QUANTITIES

Case Code	Bulk	Tape & Reel
0402	10000 pcs.	10000 pcs/reel
0603	5000 pcs.	4000 pcs/reel
0805	5000 pcs.	4000 pcs/reel
1206	5000 pcs.	4000 pcs/reel
1210	5000 pcs.	4000 pcs/reel
1808	1000 pcs	1000 pcs/reel
1812	1000 pcs	1000 pcs/reel
2220	1000 pcs	1000 pcs/reel
2225	1000 pcs	1000 pcs/reel
3012	1000 pcs	500 pcs/reel
3035	1000 pcs	500 pcs/reel

Special package quantity available upon request and factory approval.

Example below indicates : SNPO series, 470 pF, 5%, 50 Volt, Tape/Reel packed, 0805 case size.

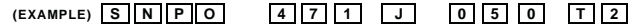

Series ————

Series Code: SNPO, SX7R, SZ5U, SY5V.
Note: SNPO indicates COG(NPO) dielectric

Capacitance ————

3 Digit Capacitance Code (per EIA Standard):
First Two Digits Represent Significant Figures of Capacitance in pF.
Third Digit Indicates Number of Zeros
For Values Below 10 pF, R replaces second digit to indicate a decimal point.
Example: 471 = 470 pF., 1R5 = 1.5 pF.

Tolerance ————

Capacitance Tolerance Code:
Capacitance Tolerance $\pm .25 \text{ pF}$ $\pm .5 \text{ pF}$ $\pm 1\%$ $\pm 2\%$ $\pm 5\%$ $\pm 10\%$ $\pm 20\%$ $-20 + 80\%$
Code C D F G J K M Z

Rated Voltage ————
3 Digit Voltage Code:
Rated Voltage(V) 6.3 10 16 25 50 100 200 250 500 1000 2000 3000 4000
Code 006 010 016 025 050 100 200 250 500 1KV 2KV 3KV 4KV

Packing Code ————

Code	Style
T	Tape & Reel
B	Bulk

Case Code ————

Case Code	0	1	2	3	4	5	6	7	8	9	10
Case Size	0402	0603	0805	1206	1210	1808	1812	2220	2225	3012	3035

Tape/Reel & Packaging Specifications

Taping Dimensions

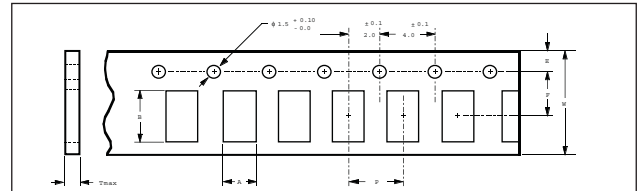

SIZE CODE	A	B	W	F	E	P	Tmax
0402	$\pm 0.1 \text{ mm or } \pm 0.004"$ 0.7 (0.028)	$\pm 0.1 \text{ mm or } \pm 0.004"$ 1.3 (0.051)	$\pm 0.3 \text{ mm or } \pm 0.012"$ 8.0 (0.315)	$\pm 0.1 \text{ mm or } \pm 0.004"$ 3.5 (0.138)	$\pm 0.1 \text{ mm or } \pm 0.004"$ 1.75 (0.069)	$\pm 0.1 \text{ mm or } \pm 0.004"$ 4.0 (0.157)	1.7 (0.067)
0603	1.1 (0.043)	1.9 (0.075)	8.0 (0.315)	3.5 (0.138)	1.75 (0.069)	4.0 (0.157)	1.7 (0.067)
0805	1.7 (0.067)	2.4 (0.094)	8.0 (0.315)	3.5 (0.138)	1.75 (0.069)	4.0 (0.157)	1.7 (0.067)
1206	2 (0.079)	3.6 (0.142)	8.0 (0.315)	3.5 (0.138)	1.75 (0.069)	4.0 (0.157)	1.7 (0.067)
1210	2.8 (0.110)	3.7 (0.147)	8.0 (0.315)	3.5 (0.138)	1.75 (0.069)	4.0 (0.157)	1.7 (0.067)
1808	2.4 (0.094)	4.9 (0.193)	12.0 (0.472)	3.5 (0.138)	1.75 (0.069)	4.0 (0.157)	1.7 (0.067)
1812	3.6 (0.142)	4.9 (0.193)	12.0 (0.472)	3.5 (0.138)	1.75 (0.069)	4.0 (0.157)	1.7 (0.067)
2220	5.2 (0.205)	6.0 (0.236)	12.0 (0.472)	3.5 (0.138)	1.75 (0.069)	4.0 (0.157)	1.7 (0.067)
2225	6.6 (0.260)	6.0 (0.236)	12.0 (0.472)	3.5 (0.138)	1.75 (0.069)	4.0 (0.157)	1.7 (0.067)

Reel Dimensions

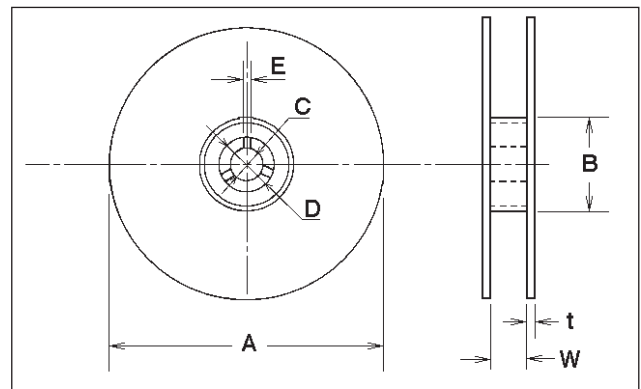

Reel Dimensions in Millimeters

A	B	C	D	E	W	t
$\phi 178 \pm 2.0$	$\phi 50 \text{ min.}$	13.0 ± 0.5	21.0 ± 0.8	2.0 ± 0.8	$8.8/12.8 \pm 1.5$	2.0 ± 0.5
$\phi 330 \pm 2.0$	$\phi 100 \text{ min.}$	13.0 ± 0.5	21.0 ± 0.8	2.0 ± 0.8	$8.8/12.8 \pm 1.5$	2.0 ± 0.6

Reel Dimensions in Inches

A	B	C	D	E	W	t
$\phi 7 \pm 0.08$	$\phi 2.0 \text{ min.}$	5.0 ± 0.02	0.83 ± 0.03	0.08 ± 0.3	$0.35/0.50 \pm 0.06$	0.08 ± 0.02
$\phi 13 \pm 0.08$	$\phi 4.0 \text{ min.}$	5.0 ± 0.3	0.83 ± 0.03	0.08 ± 0.3	$0.35/0.50 \pm 0.06$	0.08 ± 0.02

Reliability and Test Conditions

Parameter	Specification	Test Method
Capacitance	Within tolerance specified in the part number	Class(I) C≤1000 pF: 1 MHz. ±10% 0.5 to 5 V rms
Dissipation Factor (Tan δ and Q)	Class(I) C<30 pF: Q≥400+20xC C30 pF: Q>1000 Class(II) X7R: DF≤3%, Z5U: DF≤3%, Y5V: DF≤5%	C>1000 pF: 1 KHz. ±10% 1.0 ±0.2 V rms Class(II) 1 KHz. ±10%, 1.0 ±0.2 V rms
Insulation Resistance (IR)	C≤50,000 IR: >10 G Ohms C≤50,000 IR: >500 Ohms.F	Apply rated voltage for 60 seconds at room temperature and normal humidity (70% max.)
Dielectric Withstanding Voltage	There shall be no evidence of damage or flash over during the test.	Apply rated voltage (Class I) or 2.5 x rated voltage (Class II) to both terminations for 5 seconds. Charge and discharge current are less hat 50 mA.
Termination Adherence	No mechanical damage	After soldering capacitor on the glass-epoxy PWB, 50 gms of steady pull is applied in direction of arrow for 10 seconds. (See Figure 1)
Bend Strength	No mechanical damage	After soldering capacitor on the glass-epoxy PWB, 2 mm of bending shall be applied for 10 seconds as shown in the drawing. (See Figure 2)
Life Test (High Temperature Loading test) - Capacitance Change	Class(I): No more than ±3% or ±0.3 pf which ever is more. Class(II): X7R: ±10% max. Z5U, Y5V: ±30% max.	Apply 2 x rated voltage at maximum operating temperature for 1000 hours. The surge current shall not exceed 50 mA. After this, the samples shall be kept in room temperature for 24 hours (Class I) or 48 hours (class II) and then measured for the parameters indicated.
Life Test (High Temperature Loading test) - DF or Q	Class(I) C<10 pF: Q≥200+10xC 10 pF≤ C < 30 pF Q≥275+2xC: C>30 pF: Q>350 Class(II) X7R: DF≤5% Z5U & Y5V: DF≤7.5%	
Life Test (High Temperature Loading test) - IR	1000 M Ohms or 50 Ohms.F whichever is less	

Figure 1

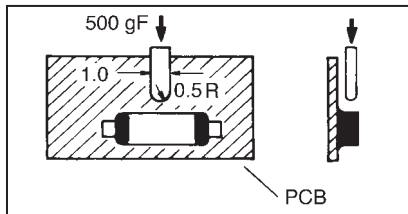
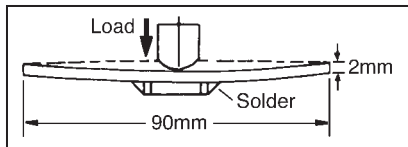

Figure 2



Parameter	Specification	Test Method
Moisture Resistance Test - Capacitance change	Class(I): No more than ±5% or ±0.5 pf which ever is more. Class(II): X7R: ±10% max. Z5U & Y5V: ±30% max.	The capacitor shall be subjected to 40 °C and 90 to 95% RH for 500 hours. After this, samples shall be
Moisture Resistance Test - Q or DF	Class(I) C<10 pF: Q≥200+10xC 10 pF≤ C < 30 pF Q≥275+2xC: C≥30 pF: Q≥350 Class(II) X7R: DF≤5% Z5U & Y5V: DF≤7.5%	kept in room temperature for 24 hrs. (Class I) or 48 hrs. (Class II), and them shall be measured (Class I) or 48 hours (Class II) and then measured for the parameters indicated.
Moisture Resistance Test - IR	1000 M Ohms or 50 Ohms.F whichever is less	
Humidity Load Test - Capacitance change	Class(I): No more than ±7.5% or ±0.75 pf which ever is more. Class(II): X7R: ±12.5% max. Z5U, Y5V: ±30% max.	The capacitor shall be subjected to rated voltage at 40 °C and 90 to 95 % RH for 500 hours. Surge current shall not exceed 50 mA. After this, samples shall be kept in room temperature for 24 hrs. (Class I) or 48 hours (Class II), and them shall be measured (Class I) or 48 hours (Class II) and then measured for the parameters indicated.
Humidity Load Test Q or DF	Class(I) C<30 pF: Q≥ 100+3xC C ≥ 30 pF: Q≥200 Class(II) X7R: DF≤5% Z5U & Y5V: DF≤7.5%	
Humidity Load Test - IR	500 M Ohms or 25 Ohms.F whichever is less	
Temperature Cycling Test - Capacitance change	Class(I): No more than ±2.5% or ±0.25 pf which ever is more. Class(II): X7R: ±7.5% max. Z5U, Y5V: ±20% max.	Perform 5 cycles as follows: 1. Room temperature dwell for 15 minutes. 2. Minimum operating temperature dwell for 30 minutes.
Temperature Cycling Test - Q or DF	Parts to meet the initial specifications	3. Room temperature dwell for 30 minutes.
Temperature Cycling Test - IR	Parts to meet the initial specifications	4. Maximum operating temperature dwell for 30 minutes. After the above testing condition, samples shall be kept in room temperature for 24 hrs. (Class I) or 48 hours (Class II), and them shall be measured (Class I) or 48 hours (class II) and then measured for the parameters indicated.
Solderability	Termination area shall be at least 75% covered with a new solder coating. There shall be no crack and ceramic exposure of terminated surface due to melting.	The capacitors are completely immersed for 10 ±0.5 seconds in the molten solder with a temperature of 260±5°C solder. Cladding material of outer-electrode: Sn (~100%)
Resistance to Solder Heat Test - Capacitance Change	No more than ±2.5% or ±0.25 pf which ever is more. Class(II): X7R: ±7.5% max. Z5U, Y5V: ±20% max.	The capacitors are completely immersed for 10 ±1.0 seconds in the molten solder with a temperature of 270±5°C solder. Preheat before immersion, 1. 80 to 100 °C for 2 minutes 2. 150 to 180 °C for 2 minutes
Resistance to Solder Heat Test - Q or DF	Parts to meet the initial specifications	
Resistance to Solder Heat Test - IR	Parts to meet the initial specifications	The capacitance measurement shall be made after the samples have been kept at room temperature for 24 hours.

Class II Dielectric Code Explanation

First symbol (a letter)	Low temperature requirement	Second symbol (a number)	High Temperature requirement	Third Symbol (a letter)	MAX. Capacitance change over temperature
Z	+10 deg. C	2	+45 deg. C	A	+1.0%
Y	-30 deg. C	4	+65 deg. C	B	+/- 1.5%
X	-55 deg. C	5	+85 deg. C	C	+/- 2.2%
		6	+105 deg. C	D	+/- 3.3%
		7	+125 deg. C	E	+/- 4.7%
				F	+/- 7.5%
				P	+/- 10.0%
				R	+/- 15.0%
				S	+/- 22.0%
				T	+22%, -33%
				U	+22%, -56%
				V	+22%, -82%

SNPO Series

APPLICATION:

The SNPO series has a high Q, low K temperature compensating type of capacitance dielectric with stable electrical properties under varying voltage, temperature, frequency and time conditions. The series is suitable for circuits requiring low loss, circuits with pulse, timing circuits and for tuning applications. Typically used in R/F, microwave, and other communications equipment. Frequently designed in precision industrial controls, process control and test & measurement instrumentation. Because of its wide range of temperature stability, often used in automotive and quality audio applications.

FEATURES:

- Very low temperature coefficient
- Stable electrical characteristics
- High capacitance and miniature size
- Low and high voltage options
- Available in bulk and tape & reel packaging
- Consistent dimensions and surface finish
- Nickel barrier terminations

GENERAL SPECIFICATIONS:

Operating temperature: -55 to +125 °C
Temperature coefficient: ±30ppm per °C
Capacitance tolerance: ±5%, <10pF ±.25pF or ±.5pF standard, ±10% optional
Capacitance range: .47pF to .1uF
Voltage range: 6.3V to 4KV DC
Dielectric withstanding voltage: 2 times the working VDC for 5 seconds
Case code range: 0402 to 3035
Note: See Reliability and Test Conditions page for more specifications

Note: Extended capacitance range values, optional case codes, special tolerances may be available based on factory approval.

COG(NPO) DIELECTRIC CAPACITANCE RANGE Tolerance: (J), <5pF: ±.25pF(C), ≥5pF<10pF: ±.5pF(D) standards. Optional: (K)											
Voltage(DC)	Voltage/Case Code Options										
	0402	0603	0805	1206	1210	1808	1812	2220	2225	3012	3035
6.3V		18-820pF									
10V		12-680pF									
16V	.62-470pF	2-680pF									
25V	.47-560pF	.47-1000pF	.47-3300pF	.47-4700pF	560pF-.01uF		1000pF-.015uF		1000pF-.047uF		1000pF-.1uF
50V	.47-330pF	.47-1000pF	.47-2200pF	.47-4700pF	10pF-.015uF	10-3300pF	10pF-.022uF		1000pF-.022uF		1000pF-.047uF
100V		.47-1000pF	.47-2200pF	.47-3300pF	10-6800pF	10-4700pF	10pF-.01uF		10pF-.01uF	470pF-.022uF	1000pF-.033uF
200V		.47-1000pF	.47-1500pF	.47-2200pF	10-3300pF	10-4700pF	10-5600pF		10pF-.012uF	470pF-.01uF	
250V			.47-820pF	.47-2200pF	10-3300pF	10-4700pF	10-5600pF		10pF-.012uF	470pF-.01uF	
500V			.47-560pF	.47-2700pF	10-2700pF	10-4700pF	10-4700pF		10-6800pF	470-6800pF	.01-.022uF
1KV				.47-680pF	10-1000pF	10-4700pF	10-2200pF		10-2700pF	470-2700pF	
2KV				.47-470pF	10-470pF	10-2200pF	10-1000pF		10-1000pF	470-1000pF	
3KV						10-1000pF	10-1000pF		10-680pF	470-1000pF	
4KV						10-470pF	10-330pF		10-560pF	470-1000pF	

COG / NPO is a dielectric with stable electrical properties under varying voltage, temperature, frequency and time.

This dielectric has the least value of temperature coefficient. The temperature coefficient characteristics is illustrated in Figure 1.1 Figure 1.2 illustrates the variation pattern of Dissipation Factor with respect to temperature.

The DC Voltage coefficient and AC Voltage coefficient are illustrated in Figures 1.3 and 1.4 respectively.

COG (NPO) Characteristic Graphs

FIGURE 1.1

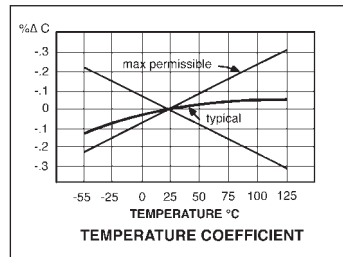

FIGURE 1.2

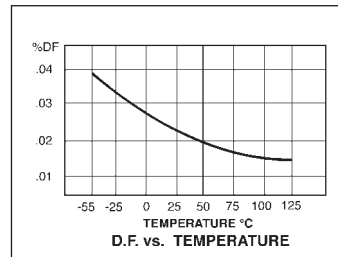

FIGURE 1.3

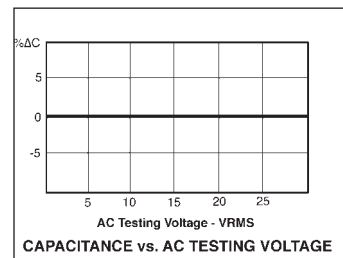
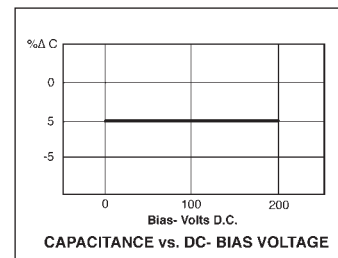

FIGURE 1.4



SX7R Series

APPLICATION:

The SX7R series has a moderate K temperature compensating type of capacitance dielectric and is temperature stable. It shows moderate change in electrical properties under changing temperature, voltage and frequency conditions. The series is suitable for by-passing, coupling, and frequency discriminating circuit applications.

Typically used in computer and data processing products and equipment. It offers relatively stable characteristics at a lower cost consideration than the SNPO series. This series has higher capacitance range options than the SNPO range.

FEATURES:

- Stable electrical characteristics
- High capacitance and miniature size
- Available in bulk and tape & reel packaging
- Low and high voltage options
- Consistent dimensions and surface finish
- Nickel barrier terminations

GENERAL SPECIFICATIONS:

Operating temperature: -55 to +125 °C
Temperature coefficient: ±15% value change
Capacitance tolerance: ±10% standard, ±20% optional
Capacitance range: 10pF to 4.7uF
Voltage range: 6.3V to 4KV DC
Dielectric withstanding voltage: 2 times the working VDC for 5 seconds
Case code range: 0402 to 3035

Note: See Reliability and Test Conditions page for more specifications

Note: Extended capacitance range values, optional case codes, special tolerances may be available based on factory approval.

Voltage(DC)	X7R DIELECTRIC CAPACITANCE RANGE Tolerance: (K) standard Optional: (M)										
	Voltage/Case Code Options										
	0402	0603	0805	1206	1210	1808	1812	2220	2225	3012	3035
6.3V		.001-.0068uF	.0082-1uF	1-4.7uF							
10V	150pF-.033uF	.12-.22uF	.1-.47uF	1-4.7uF							
16V	150pF-.033uF	.12-.22uF	.1-.47uF	1000pF-1uF	10pF-2.2uF						
25V	150pF-.022uF	.01-.1uF	220pF-1uF	1000pF-1uF	10pF-2.2uF		.01-.47uF		.01-1uF		.01-2.2uF
50V	150pF-.01uF	150pF-.056uF	10pF-1uF	330pF-1uF	10pF-2uF		.01-.33uF		.01-1uF		.01-2.2uF
100V		100pF-.01uF	10pF-1uF	10pF-.33uF	10pF-.22uF	150pF-.22uF	150pF-.47uF		150pF-1.2uF	6800pF-1uF	.01-1uF
200V		100pF-.068uF	10pF-.022uF	10pF-.068uF	10pF-.1uF	150pF-.1uF	150pF-.22uF		150pF-.47uF	6800pF-1uF	
250V		100-4700pF	10pF-.022uF	10pF-.047uF	10pF-.1uF	150pF-.1uF	150pF-.15uF		150pF-.47uF	6800pF-1uF	
500V			10pF-.01uF	10pF-.026uF	150pF-.068uF	150pF-.047uF	150pF-.1uF		150pF-.39uF	1000pF-1uF	
1KV				10pF-.01uF	150pF-.015uF	150pF-.022uF	150pF-.027uF		150pF-.056uF	.0027-.047uF	
2KV				10pF-.027uF	150pF-.01uF	150pF-.01uF	150pF-.01uF		150pF-.047uF	.001-.022uF	
3KV						150-4700pF	150-2200pF		150-6800pF	1000-6800pF	
4KV						150-2000pF	150-1500pF		150-3900pF	.001-.01uF	

X7R is a moderately stable dielectric under changing temperature, voltage and frequency conditions.

This dielectric has moderate value of temperature coefficient. The temperature coefficient characteristics is illustrated in Figure 2.1. Figure 2.2 illustrates the variation pattern of Dissipation Factor with respect to temperature.

The DC Voltage coefficient and AC Voltage coefficient are illustrated in Figure 2.3 and 2.4 respectively.

X7R Characteristic Graphs

FIGURE 2.1

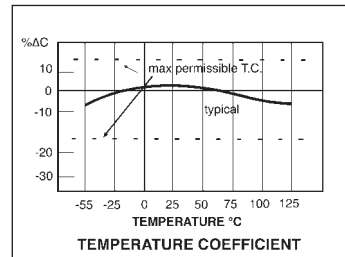

FIGURE 2.2

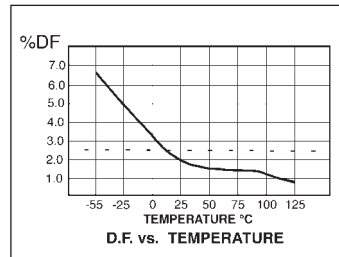

FIGURE 2.3

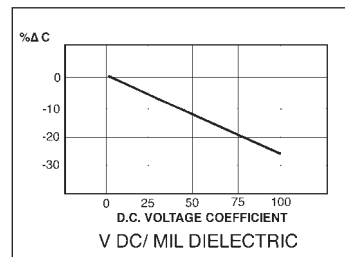
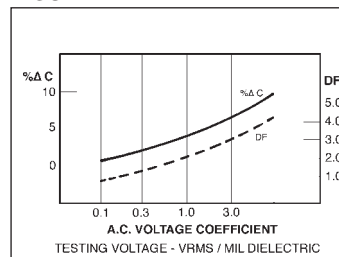

FIGURE 2.4



SY5V Series

APPLICATION:

The SY5V series has a relatively high K temperature compensating type of capacitance dielectric. The electrical properties can vary widely under changing temperature, voltage, and time conditions. They are suitable for all general purpose applications where higher capacitance values are required. Best when used in non-critical, room temperature stable conditions with low DC bias. Suitable for de-coupling applications in stable temperature conditions.

FEATURES:

- High capacitance values
- Miniature size
- Low and high voltage options
- Available in bulk and tape & reel packaging
- Low cost for high capacitance
- Consistent dimensions and surface finish
- Nickel barrier terminations

GENERAL SPECIFICATIONS:

Operating temperature: -30 to +85 °C
Temperature coefficient: -82% to +22% value change over operating temperature
Capacitance tolerance: ±20% standard, -20%/ +80% optional
Capacitance range: 2200pF to 10uF
Voltage range: 10V to 500V DC
Dielectric withstanding voltage: 2 times the working VDC for 5 seconds
Case code range: 0402 to 3035

Note: See Reliability and Test Conditions page for more specifications

Note: Extended capacitance range values, optional case codes, special tolerances may be available based on factory approval.

Y5V DIELECTRIC CAPACITANCE RANGE Tolerance: (M) standard Optional: (Z)											
Voltage(DC)	Voltage/Case Code Options										
	0402	0603	0805	1206	1210	1808	1812	2220	2225	3012	3035
6.3V											
10V	.01-.1uF	.27-1uF	.27-3.3uF								
16V	.01-.1uF	.27-1uF	.27-3.3uF	.27-6.8uF	.1-10uF						
25V	.01-.056uF	.047-.47uF	.01-2.2uF	.01-3.3uF	.1-10uF		.15-3.3uF		.68-4.7uF		1-10uF
50V	.01-.033uF	.01-.22uF	.01-.68uF	.01-2.2uF	.1-3.3uF		.15-2.2uF		.68-3.3uF		1-6.8uF
100V		2200pF-.068uF	.01-.22uF	4700pF-1uF	.22-2.2uF	.01-.82uF	.01-2.2uF		.01-2uF	6800pF-1.5uF	
200V		4700pF-.068uF	.01-.056uF	.01-.47uF	.01-.39uF	4700pF-.39uF	.01-.47uF		.01-.68uF	6800pF-1uF	
250V			.01-.056uF	.01-.47uF	.01-.39uF	4700pF-.39uF	.01-.47uF		.01-.68uF	6800pF-1uF	
500V					.012-.047uF						
1KV											
2KV											
3KV											
4KV											

Y5V Characteristic Graphs

The temperature coefficient characteristics of Y5V is illustrated in Figure 3.1. Figure 3.2 illustrates the variation pattern of Dissipation Factor with respect to temperature. The DC Voltage coefficient and aging pattern are illustrated in Figure 3.3 and 3.4 respectively.

FIGURE 3.1

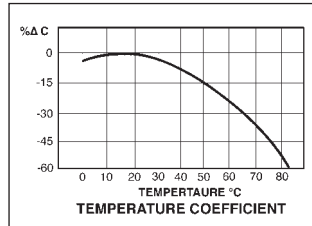

FIGURE 3.2

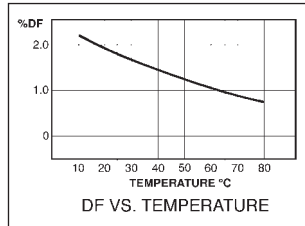

FIGURE 3.3

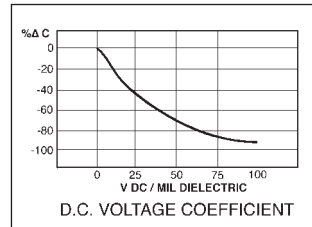
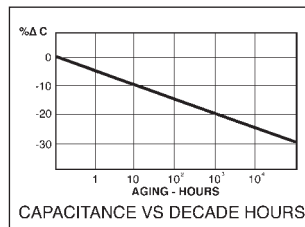

FIGURE 3.4



SZ5U Series

APPLICATION:

The SZ5U series has a high K temperature compensating type of capacitance dielectric. The electrical properties of this dielectric changes considerably under changing temperature, voltage and time conditions. High capacitance values are available for general purpose applications. Well suited for filtering, transient suppression blocking, and charge storage requirements.

FEATURES:

- High capacitance values
- Miniature size
- Low and high voltage options
- Available in bulk and tape & reel packaging
- Low cost for high capacitance
- Consistent dimensions and surface finish
- Nickel barrier terminations

GENERAL SPECIFICATIONS:

Operating temperature: +10 to +85 °C
Temperature coefficient: -56% to +22% value change over operating temperature
Capacitance tolerance: ±20% standard, -20%/ +80% optional
Capacitance range: 1000pF to 10uF
Voltage range: 10V to 1KV DC
Dielectric withstanding voltage: 2 times the working VDC for 5 seconds
Case code range: 0603 to 3035
Note: See Reliability and Test Conditions page for more specifications

Note: Extended capacitance range values, optional case codes, special tolerances may be available based on factory approval.

Z5U DIELECTRIC CAPACITANCE RANGE Tolerance: (M) Standard Optional: (Z)											
Voltage(DC)	Voltage/Case Code Options										
	0402	0603	0805	1206	1210	1808	1812	2220	2225	3012	3035
6.3V											
10V		.18-.22uF	.18-.47uF								
16V		.18-.22uF	.18-.47uF	.18-2.2uF	.01-4.7uF						
25V		.01-.22uF	.01-1uF	.01-2.2uF	.01-4.7uF		.15-3.3uF		.68-4.7uF		1-10uF
50V		.01-.1uF	.01-.68uF	.01-1uF	.01-2.2uF		.15-2.2uF		.68-3.3uF		1-6.8uF
100V			.01-.22uF	.01-.47uF	.01-1uF		.1-2.2uF				
200V				.01-.1uF	.01-.22uF						
250V											
500V				.01-.047uF	.01-.1uF						
1KV				1000-4700pF	1000pF-.01uF						
2KV											
3KV											
4KV											

Z5U Characteristic Graphs

FIGURE 4.1

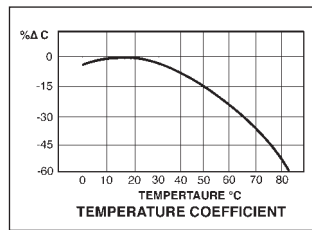
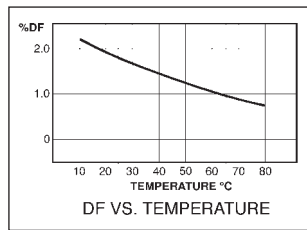

FIGURE 4.2



The temperature coefficient characteristics of Z5U is illustrated in Figure 4.1. Figure 4.2 illustrates the variation pattern of Dissipation Factor with respect to temperature. The DC Voltage coefficient and aging pattern are illustrated in Figure 4.3 and 4.4 respectively.

FIGURE 4.3

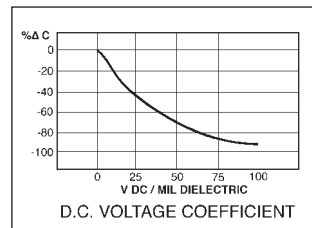
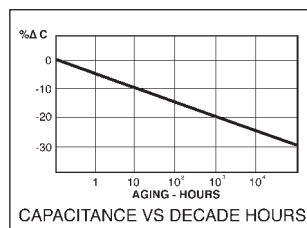

FIGURE 4.4



Introduction:

MULTILAYER CERAMIC LEADED CAPACITORS

Radial Epoxy coated multilayer ceramic capacitors available in popular COG(NPO), X7R, Y5V and Z5U dielectrics. Ideal for industrial and general purpose electronic applications. These capacitors are available in both Bulk and Tape & Reel packing for automatic insertion.

Series Specifications:	COG/NPO	X7R	Y5V	Z5U
Temperature Range in °C:	-55 to +125	-55 to +125	-30 to +85	+10 to +85
Dissipation Factor % @25°C & 1KHz:	0.25 max	3.0 max	6.0 max	4.0 max
Insulation Resistance @25°C: (minimum of)	1 G Ohm or 100 Ohm F	1 G Ohm or 100 Ohm F	1 G Ohm or 100 Ohm F	1 G Ohm or 100 Ohm F
Overload Voltage(25°C) 5 seconds max:	2x rated voltage	2x rated voltage	2x rated voltage	2x rated voltage
Temperature Coefficient:	±30ppm/°C	±15% chg.	-82 to +22% chg.	-56 to +22% chg.
Tolerance options:	J(5%), K(10%)	K(10%), M(20%)	M(20%), Z(-20 to +80%)	M(20%), Z(-20 to +80%)

Radial Leaded Series

Features

- COG(NPO) & X7R dielectrics in 25, 50 and 100 Volt rating. Y5V and Z5U in 25, 50, and 63 Volt rating.
- Radial configuration with choice of 2 standard lead spacing.
- Available in Bulk and Tape & Reel Packing (EIA Standard).

Style A : s = 2.5 ± 0.5mm

Style B : s = 5.0 ± 0.5mm

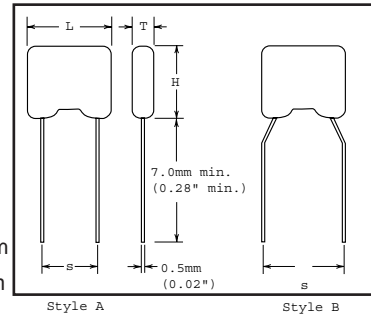

CASE CODE/ CAPACITANCE, VOLTAGE, LEAD STYLE OPTIONS TABLE

Case Code	Size Dimensions			Voltage	Capacitance Range				Lead Style
	L	H	T		COG(NPO)	X7R	Y5V	Z5U	
0805	4.1mm max.	3.8mm max.	3.2mm max.	25V	10-3300pF	220pF-1uF	.01-.1uF	.01-.22uF	A,B
				50V	10-2200pF	220pF-.1uF	.01-.68uF	.01-.1uF	A,B
				100V	10-1000pF	220pF-.068uF			A,B
1206	5.5mm max.	6.0mm max.	4.5mm max.	25V	10-4700pF	1000pF-1uF	.01-1.2uF	.01-.33uF	A,B
				50V	10-4700pF	1000pF-.1uF	.01-1uF	.01-.22uF	A,B
				100V	10-3300pF	1000pF-.068uF			A,B
1210	6.5mm max.	7.5mm max.	5.0mm max.	25V	560pF-.01uF	1000pF-.33uF	.1-2.2uF	.1-1uF	B
				50V(63V)	560pF-6800pF	1000pF-2uF	.1-2.2uF	.1-1uF	B
				100V	560pF-4700pF	1000pF-1uF			B
1812	8.5mm max.	7.5mm max.	5.0mm max.	25V	1000pF-.015uF	.01-.47uF	.15-3.3uF	.68-2.2uF	B
				50V(63V)	1000pF-.01uF	.01-.33uF	.15-3.3uF	.68-2.2uF	B
				100V	1000-6800pF	.01-.15uF			B
2225	10.5mm max.	10mm max.	6.5mm max.	25V	1000pF-.022uF	.01-1uF	1-4.7uF	1.5-3.3uF	B
				50V(63V)	1000pF-.022uF	.01-1uF	1-4.7uF	1.5-3.3uF	B
				100V	1000pF-.01uF	.01-.47uF			B

Note: Extended capacitance range values; special voltages, tolerances, lead spacing and forming may be available on factory approval.

PART NUMBERING EXPLANATION

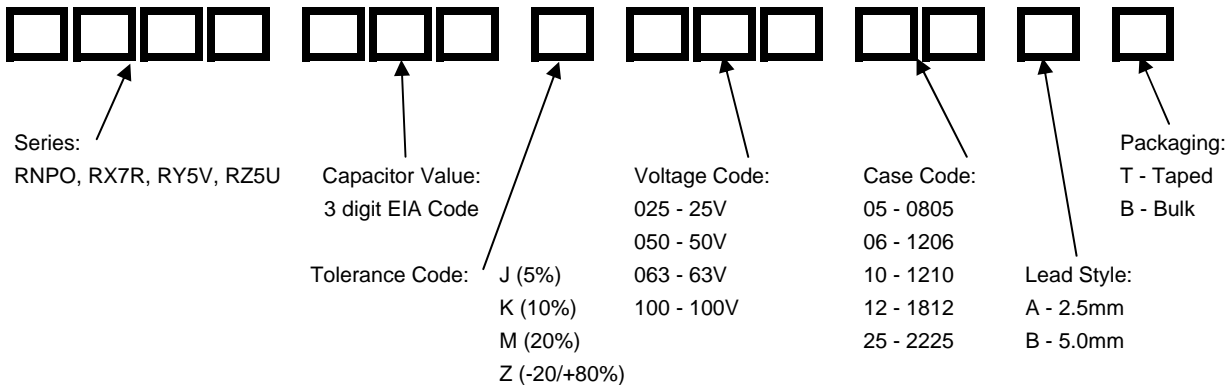

MULTILAYER CERAMIC LEADED CAPACITORS

Introduction:

Axial Epoxy coated multilayer ceramic capacitors available in popular COG(NPO), X7R and Z5U dielectrics. Ideal for industrial and general purpose electronics applications. These capacitors are available in both Bulk and Tape & Reel packing for automatic insertion.

Series Specifications:

	NPO	X7R	Z5U
Temperature Range in °C:	-55 to +125	-55 to +125	+10 to +85
Dissipation Factor % @25°C & 1KHz:	0.25 max	2.5 max	3.0 max
Insulation Resistance @ 25°C : (minimum of)	1 G Ohm or 100 Ohm F	1 G Ohm or 100 Ohm F	1 G Ohm or 100 Ohm F

Axial Leaded SERIES

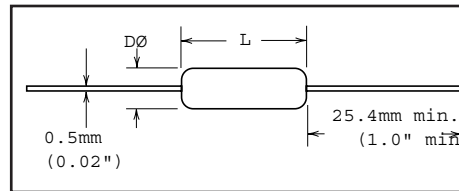

Axial Series ANPO

Rated Voltage VDC	Dielectric	Temperature Coefficient	Capacitance		Dimensions	
			Range pF	Tolerance	L max.	D max.
50	COG (NPO)	±30 ppm °C	10 to 750	J(±5%), K(±10%)	5.0 mm 0.200"	3.0 mm 0.120"

Axial Series AX7R

Rated Voltage VDC	Dielectric	Temperature Coefficient	Capacitance		Dimensions	
			Range pF	Tolerance	L max.	D max.
50	X7R	±15%	560 to 15000	K(±10%), M(±20%)	5.0 mm 0.200"	3.0 mm 0.120"

Axial Series AZ5U

Rated Voltage VDC	Dielectric	Temperature Coefficient	Capacitance		Dimensions	
			Range pF	Tolerance	L max.	D max.
50	Z5U	+22 to -56%	1000 to 100000	M(±20%) Z(-20 to +80%)	5.0 mm 0.200"	3.0 mm 0.120"

PART NUMBERING

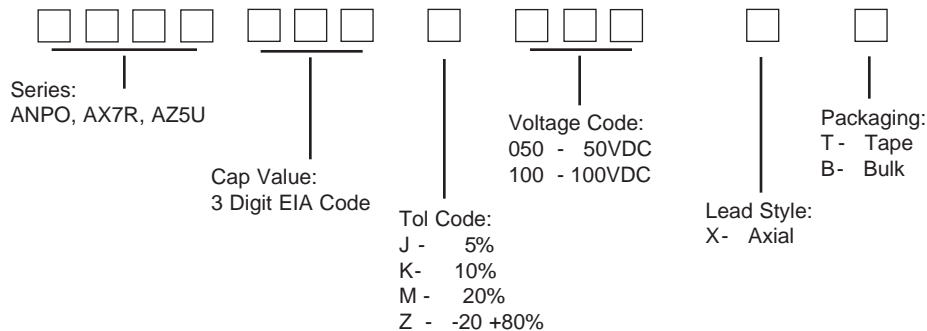

SCY1, SCY2 Series Safety Recognized Ceramic Capacitor

Specifications	
Operating Temperature	-25°C to +85°C
Capacitance Range	100pF to 10000pF (Y2 series) 100pF to 4700pF (Y1 series)
Capacitance Tolerance	K=± 10%, M=± 20%
Rated voltage	250VAC, 400VAC
Temperature Coefficient	± 10% for Y5P, +30% to -80% for Y5V (Y2 series) ± 10% for Y5P, +20% to -55% for Y5U (Y1 series)
Dissipation Factor (tand)	Y5P: 2.5% max at 25°C and 1KHz, 1±0.2 Vrms Y5V: 5% max at 25°C and 1KHz, 1±0.2 Vrms (Y2 series) Y5U: 2.5% max at 25°C and 1KHz, 1±0.2 Vrms (Y1 series)
Insulation Resistance at 25°C	10000Mohm at 500VDC for 1 minute
Dielectric Strength	2600VAC for 60 seconds (Rated voltage: 400VAC) -Y2 series 4000VAC for 60 seconds (Rated voltage: 400VAC) -Y1 series

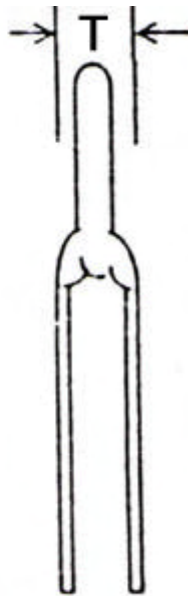
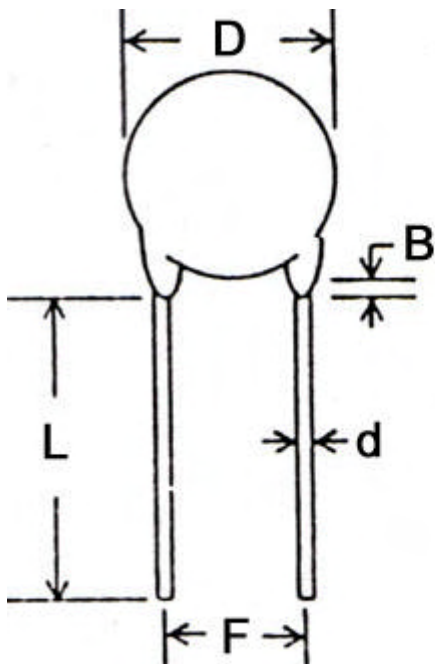

Dimensions and Tolerance:

B = 3.0 mm max

d = 0.60 mm ±0.05 mm

F = 7.5 or 9.5 ±0.8 mm (Y2 Series)

F = 9.5 ±0.8 mm (Y1 Series)

L = 5 ~ 25 mm

SCY1 Series

- Special size or items on request.
- Tolerance Dimension ± 0.5 mm.

T.C.	CAP.	TOL.	D	Dimension (mm)	T
± 10% (Y5P)	100PF	K± 10%	8	9.5± 0.8	8
	150PF		8	9.5± 0.8	8
	220PF		8	9.5± 0.8	8
	330PF		9	9.5± 0.8	8
	470PF		10	9.5± 0.8	8
	560PF		10	9.5± 0.8	8
	680PF		12	9.5± 0.8	8
	1000PF		14	9.5± 0.8	8
+20 ~ -55% (Y5U)	1000PF	M± 20%	8	9.5± 0.8	8
	1500PF		9	9.5± 0.8	8
	2200PF		12	9.5± 0.8	8
	3300PF		14	9.5± 0.8	8
	3900PF		14	9.5± 0.8	8
	4700PF		16	9.5± 0.8	8

SCY2 Series

- Special size or items on request
- Tolerance Dimension ± 0.5 mm.

T.C.	CAP.	TOL.	D	Dimension (mm)	T
± 10% (Y5P)	100PF	K± 10%	8	7.5± 0.8	5
	150PF		8	7.5± 0.8	5
	220PF		8	7.5± 0.8	5
	330PF		8	7.5± 0.8	5
	470PF		8	7.5± 0.8	5
	560PF		10	7.5± 0.8	5
	680PF		10	7.5± 0.8	5
	1000PF		12	7.5± 0.8	5

+30 ~ -80% (Y5V)	1000PF	M± 20%	8	7.5±0.8	5
	1500PF		8	7.5±0.8	5
	2200PF		9	7.5±0.8	5
	3300PF		10	7.5±0.8	5
	3900PF		12	7.5±0.8	5
	4700PF		12	7.5±0.8	5
	6800PF		16	9.5±0.8	5
	8200PF		16	9.5±0.8	5
	10000PF		18	9.5±0.8	5

PART NUMBERING EXPLANATION

